

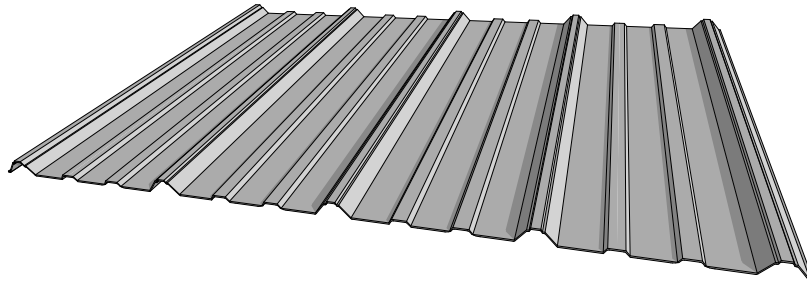

TUFF RIB PANEL



Warranty:

The tuff rib panel is covered by a 40 year limited warranty. To see warranty details click [HERE](#). Some exclusions may apply.

Specs:

- 36" coverage
- 9" major rib spacing
- 3/4" major rib height
- 29 ga. grade 80 (standard)
- Minimum recommend roof slope 3:12
- Solar reflectivity index : varies per color
- Available with drip stop, and as a vented panel.

FASTENING AT PANEL ENDS



FASTENING AT PANEL MIDDLE



PLACE SCREWS IN FLAT
ADJACENT TO PRIMARY RIBS

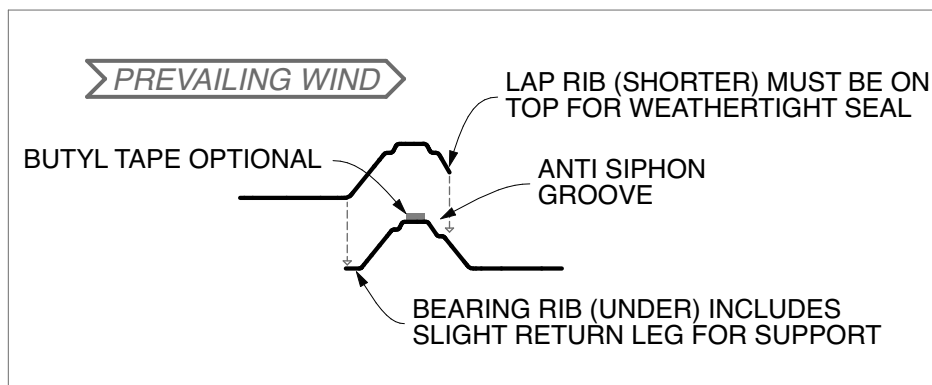



SAFETY

Metal roofs can become extremely slippery due to dust, moisture, frost, oil, etc. Wear slip-resistant shoes and monitor changing conditions throughout the project.

Exercise caution when working at height and use appropriate fall protection measures. Always stay aware of your position on the roof in relation to co-workers, roof edges, skylights, and other hazards.

Metal panels & trim conduct electricity. Use extreme caution when working near power lines or electrical supply.

Do not walk on metal.

Metal sheets are heavy and unwieldy. Do not attempt to install in windy conditions.

Metal edges are sharp. Cutting metal can produce sharp filings. Wear gloves and eye protection.

STORAGE

Projects should be coordinated and scheduled to minimize storage time and potential damage. Materials should be kept dry and out of harm's way. Store apart from corrosive or contaminating substances such as fuel, oil, acid, cleaners, paint, etc.

If storing outside:

1. Isolate from ground moisture with plastic sheet
2. Support sheets at intervals to avoid sagging
3. Elevate bundles to allow air circulation
4. Slope bundles lengthwise for drainage
5. Shelter with a loose tarp to allow air circulation
6. Do not store outside for more than 4 weeks

If stacked sheets get wet inside the bundle they must be separated and dried thoroughly before being restacked. Prolonged moisture exposure while stacked will damage the finish. Damage from improper storage is not covered by warranty.

HANDLING

Bundled panels and trim are heavy. Provide sufficient manpower.

Trim and panels should be carried edgeways (not flat) and handled in a way that avoids bending, kinking or distorting the profile. Long panels and trim may require multiple people to handle properly.

Metal ribs and trim should not be stepped on at any time.

DRIPSTOP

Condensation forms when there is a great difference between temperatures this often happens between the transition of night and day. Dripstop has a membrane structure that absorbs, releases and directs condensation without using any chemical agents.

Dripstop helps fight corrosion and inhibits mold while still retaining its effectiveness over the entire course of its lifespan.

1. Panels with dripstop applied have an increased coverage of 1/8" to 1/4"
2. Dripstop will only control condensation when installed to vent properly.



COMMON TRIMS

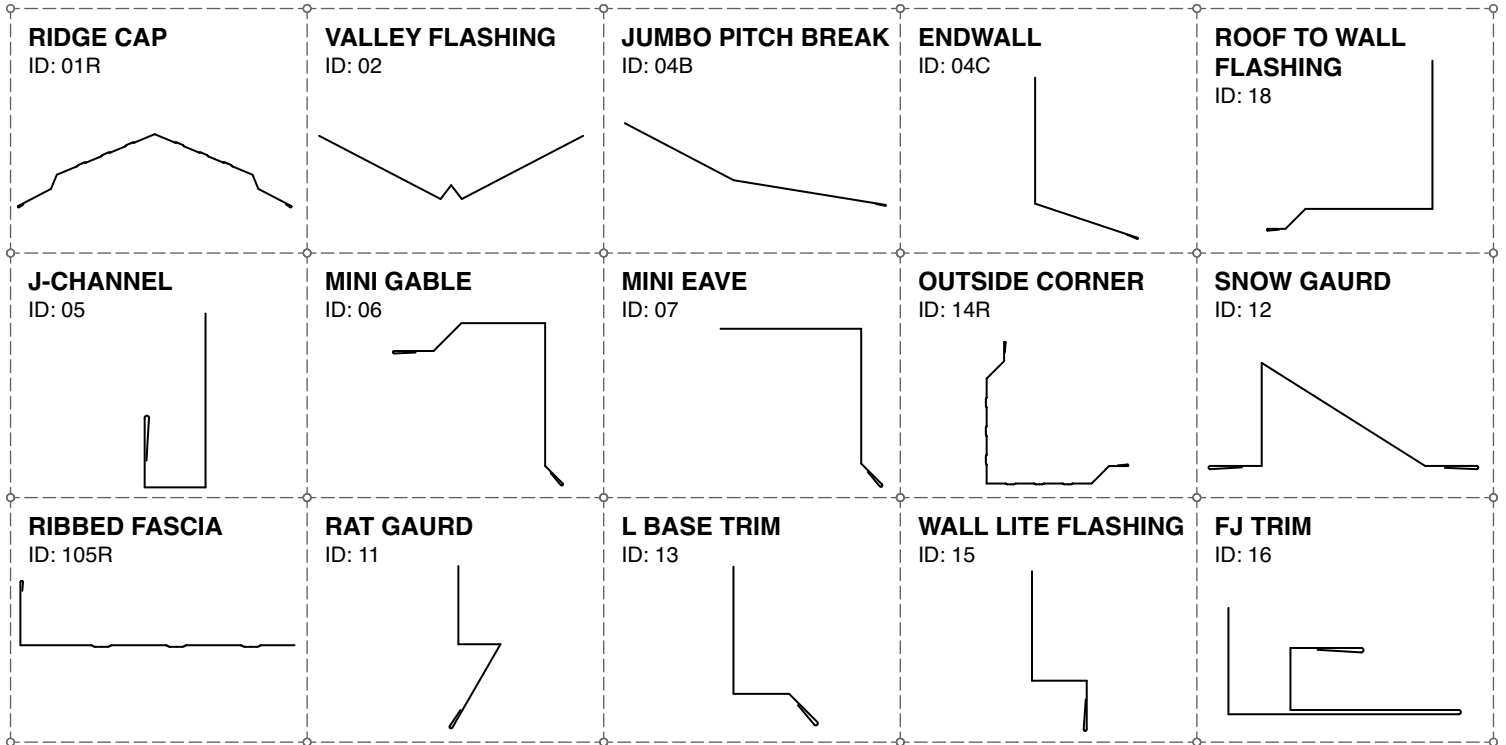

Additional standard and custom profiles available for order

INSTALLATION

Install flashing from the bottom up. Make sure that all laps face downward for drainage and channel water away/out from the structure. Do not rely entirely upon sealant!

Do not use abrasive blades to cut (grinder cut-off wheels and such like). The heat produced will burn the finish causing rust and discoloration.

Clean up all filings and scraps from the surface. These can leave rust spots.

Use approved high temperature underlayment

Screws should not be placed in either major or minor ribs.

Screws should be placed on either side of major rib at beginning and end of panel

In-between beginning and end of panel, screws should be placed beside the major rib on the overlap side of the panel.

Screws should be spaced in accordance with the substrate.

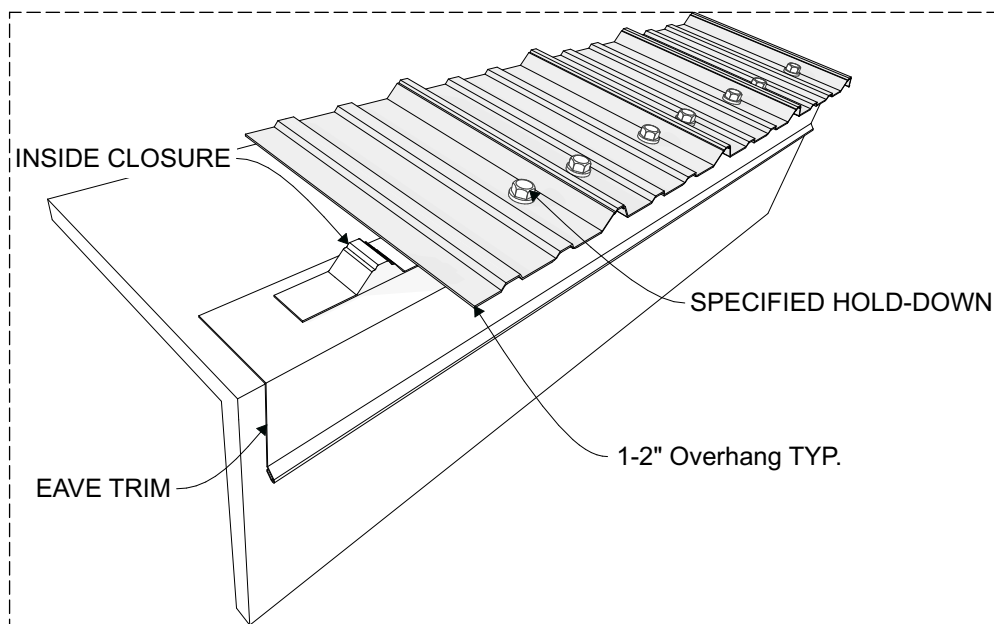
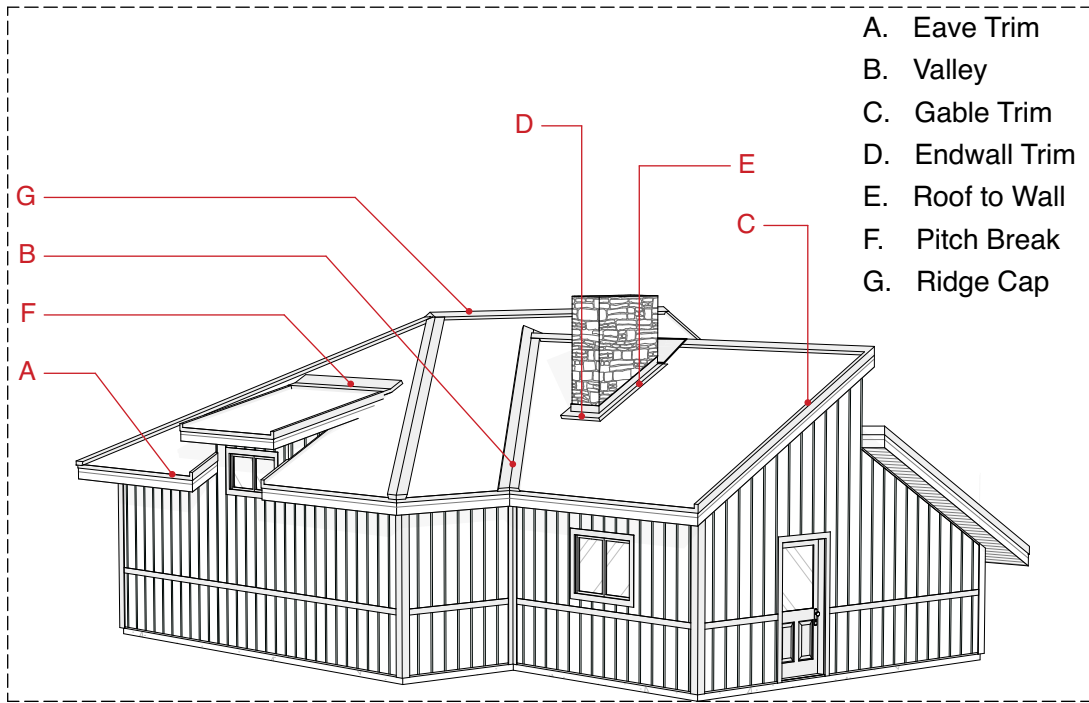

A | EAVE TRIM

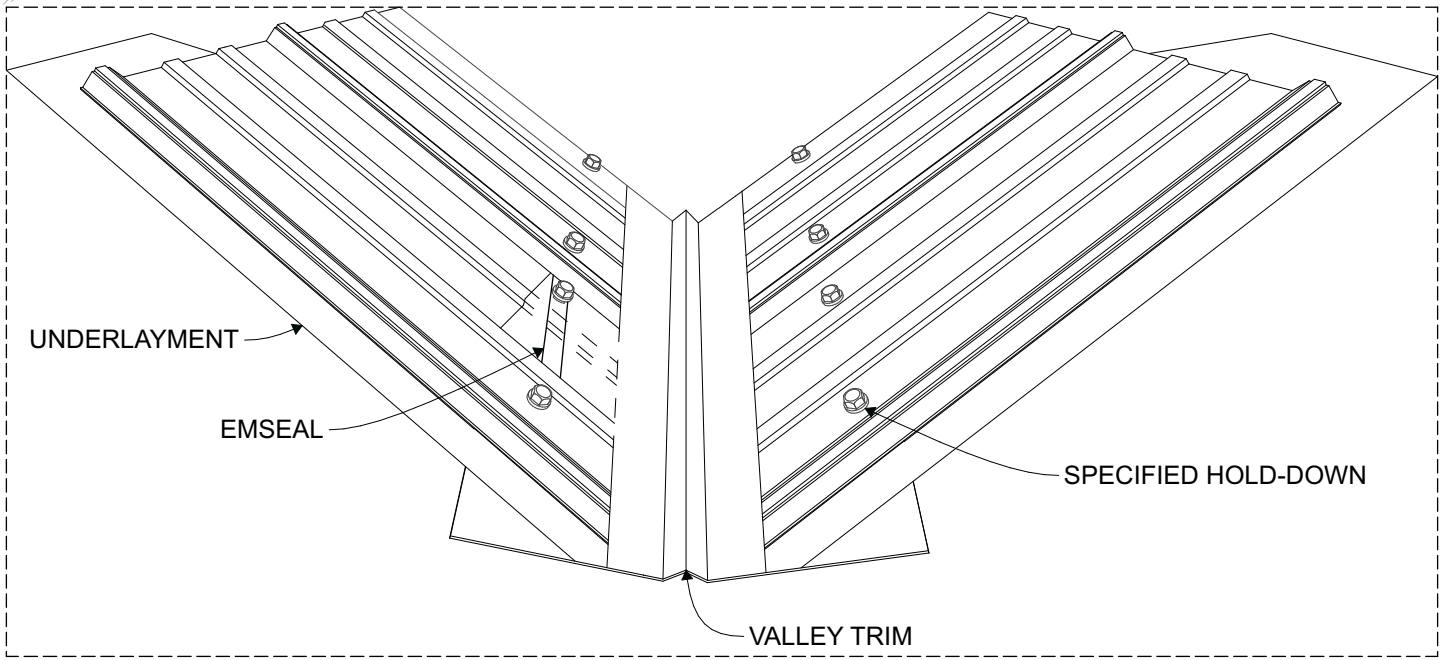

B | Valley Detail

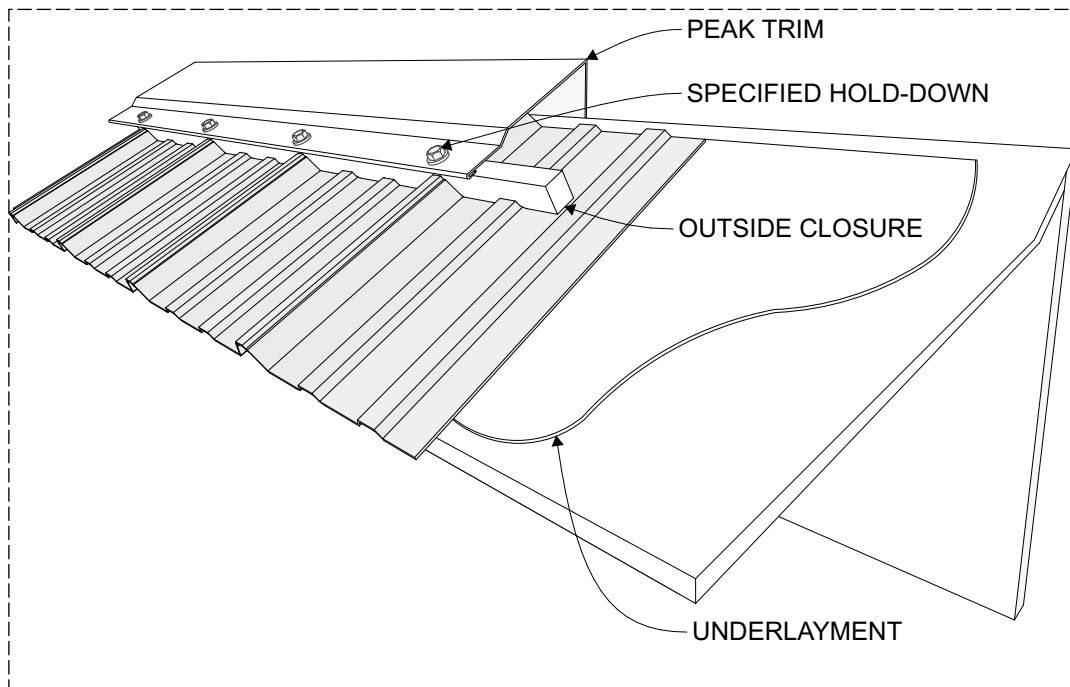

C | Peak Trim

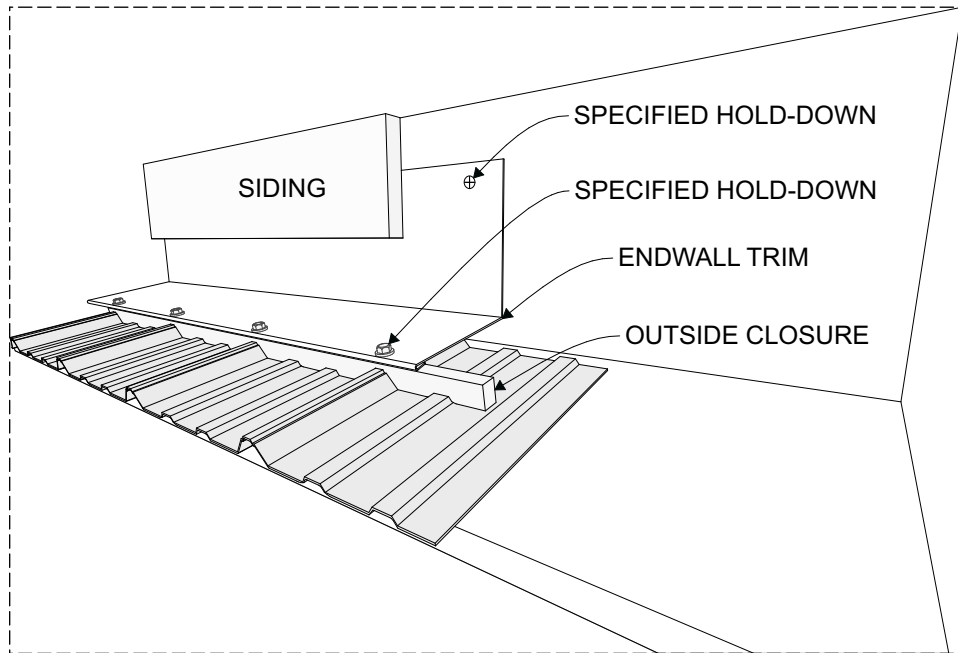

D | Endwall Trim

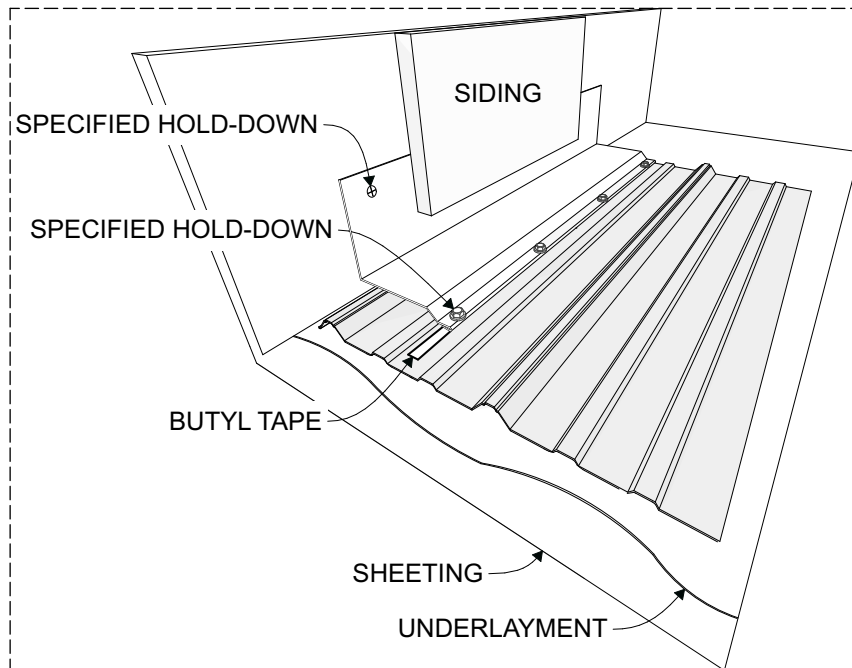

E | Roof To Wall Trim

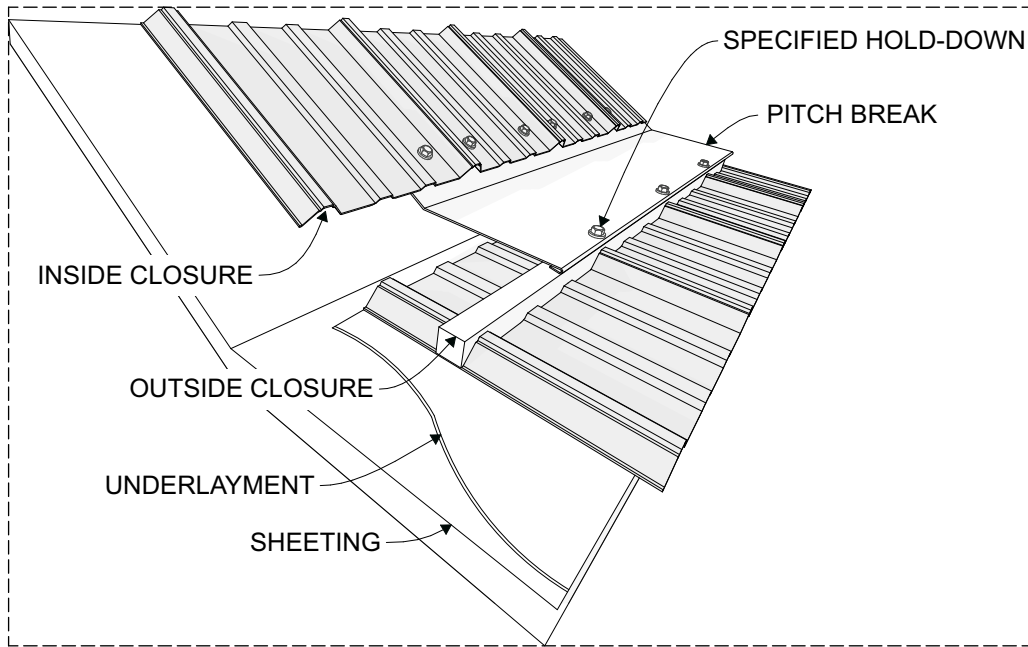

F | Pitch Break

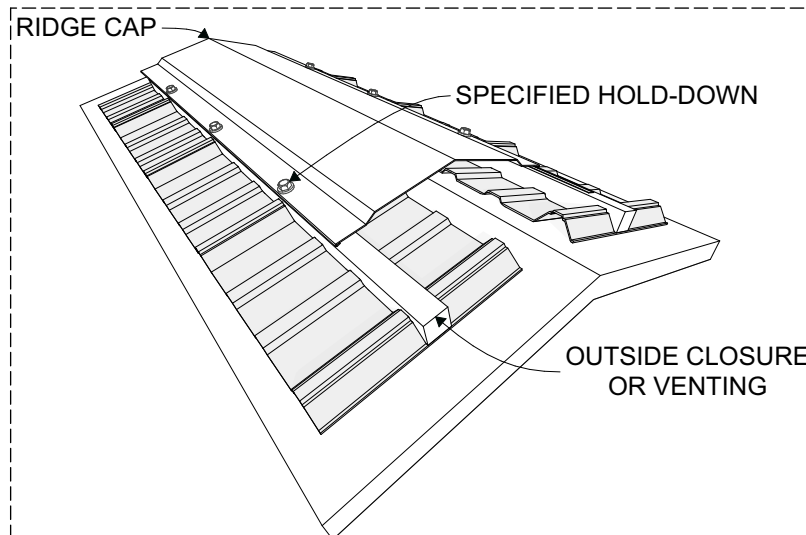

G | Ridge Cap

